

Rv151

Schnellverschraubung aus Messing



ROSSMANEK

DER GRÜNE
PNEUMATIK-KATALOG



ZTR Rossmannek GmbH

Am Pickhammer 9

D-58802 Balve

info@ztr.de

www.ztr.de

Fon: +49 (0) 2375/9299-0

Fax: +49 (0) 2375/9299-21

2.1

Bestellnummer- System

101.

01.

08.

13

Serie	Bezeichnung
101:	Steckverbinder aus Metall- vernickelt
102:	Steckverbinder aus Kunststoff
103:	Steckverbinder aus Edelstahl
106:	Modular Air- Clip- System
109:	Kunststoffsteckverbinder, große Nennweite
111/112:	Funktionsverschraubung
116:	Funktionsverschraubung für Serie 106
151:	Schnellverschraubung aus Metall
152:	Schnellverschraubung aus Kunststoff
201:	Klemmringverschraubung aus Metall und Zubehör
202:	Klemmringverschraubung aus Kunststoff und Zubehör
203:	Verschraubung aus Edelstahl
207:	Verschraubungszubehör aus Messing
208:	Verschlussstopfen
209:	Verschraubungszubehör aus Metall, vernickelt
300:	Kupplungen und Zubehör
400:	Kugelhähne
500:	Schlauch, Rohr und Zubehör
600:	Manometer (siehe auch Schlüssel bei Serie 600)
700:	Druckluftaufbereitung
800:	Schalldämpfer
900:	Balgzylinder und Schwingungsisolatoren

Nummer	Anschluss
00:	neutral
04:	4 mm
05:	5mm
06:	6mm
08:	8mm
09:	1/8" NPT
10:	10mm- 1/8" (zyl./kon.)
12:	12mm- 1/4" NPT
13:	1/4" (zyl./kon.)
14:	14mm
16:	3/8" NPT
17:	3/8" (zyl./kon.)
20:	1/2" NPT
21:	1/2" (zyl./kon.)
26:	3/4" NPT
27:	3/4" (zyl./kon.)
31:	M6 x 0,75
32:	M6 x 1
34:	1" (zyl./kon.)
35:	M7
38:	M8
44:	M10
51:	M12 x 1
52:	M12 x 1,25
53:	M12 x 1,5

Nummer: Artikel (einige Beispiele)	
01:	gerader Einschraub- Anschluss, zyl.
02:	Winkel- Verbinder
03:	L- Einschraubanschluss, kon.
04:	T- Verbinder
05:	gerader Einschraubanschluss, kon.
06:	gerader Verbinder
07:	Kreuzverbinder
08:	T- Einschraubanschluss, drehbar, kon.
09:	Winkel- Einschraubanschluss, fest, kon.
10:	Hohlschraube
11:	Winkel- Ringanschluss
12:	T- Ringanschluss
14:	gerader Aufschraubanschluss
16:	gerader Schottverbinder
18:	Winkel- Schwenkanschluss
19:	T- Schwenkanschluss
22:	Schlauchstecktülle
23:	L- Einschraubanschluss, fest, kon.
24:	einfache Aufschraubhohlschraube
29:	Winkel- Einschraubanschluss, lang
30:	3- Wegeverteiler
32:	gerader Schottverbinder, Innengewinde
33:	Winkel- Schottverbinder
34:	T- Schottverbinder
37:	Dichtring
40:	25m Rolle Schlauch
41:	Doppel- Winkel- Einschraubanschluss, kon.
42:	Doppel- Winkel- Einschraubanschluss, zyl.
45:	Doppel- T- Einschraubanschluss
50:	50 mRolle Schlauch

Nummer: Artikel (einige Beispiele)	
50:	T- Schraub- Doppelmuffenanschluss
52:	Winkel- Schraubanschluss
55:	Doppelmuffe
56:	Aufschraubtülle
60:	6- Wege- Verteiler
60:	100m Rolle Schlauch
61:	Gerader Übergangsstutzen, konisch
62:	Verlängerung
63:	Reduzierung, konisch
66:	Reduzierung
68:	Reduzierung, zylindrisch
69:	Reduzierung
69:	Gerader Übergangsstutzen, zylindrisch
69:	Winkel- Aufschraubanschluss, drehbar
70:	Reduzierung, versenkbar
72:	Kugelhahn, IG-IG, PN25
73:	Kugelhahn, IG-AG, PN25
78:	T- Aufschraubanschluss, drehbar
79:	Winkel- Einschraubanschluss, drehbar, kon.
81:	gerader Einschraubanschluss, rund
82:	3- Wegehahn, L- Bohrung
83:	3- Wegehahn, T- Bohrung
90:	Miniatrhahn, IG-IG
90:	Winkel- Einschraubanschluss, drehbar, zyl.
91:	Winkel- Einschraubanschluss, drehbar, zyl.
91:	Einschraubtülle, zylindrisch
93:	L- Einschraubanschluss, drehbar, zyl.
95:	Doppelnippel, lösbar
97/98:	T- Einschraubanschluss, drehbar, zyl.
97:	Entlüftungskugelhahn, abschließbar

Schlauch- Farbe	
00:	farblos
10:	schwarz
20:	grün
30:	rot
40:	blau
50:	gelb
Sonderfarben:	
01:	weiss
05:	grau
25:	hellgrün
45:	hellblau
60:	Pink
70:	braun
80:	orange

**Andere Artikel
und
Ausführungen
auf Anfrage
lieferbar !**

Schnellverschraubung, Messing vernickelt

Schnellverschraubung, Messing vernickelt

151.01:Seite 4



151.05:Seite 4



151.51:Seite 5



151.55:Seite 5



151.09:Seite 5



151.91:Seite 6



151.79:Seite 6



151.08:Seite 6



151.98:Seite 6



151.03:Seite 7



151.14:Seite 7



151.69:Seite 7



151.02:Seite 7



151.04:Seite 8



151.06:Seite 8



151.07:Seite 8



151.16:Seite 8



151.11:Seite 9



151.12:Seite 9



151.88:Seite 9



151.90:Seite 10



151.29:Seite 10



151.97:Seite 10



151.96:Seite 10



151.X:Seite 11



Drossel

151.X:Seite 11



Drossel

101.10:Seite 12



101.10.D:Seite 12



101.10:Seite 12



101.10:Seite 12



101.10:Seite 12



101.24:Seite 12



151.10:ab Seite 13



mit
Knick-
schutz-
feder !



Schnellverschraubung, Messing vernickelt

Serie Rv151. Schnellverschraubung. Messing vernickelt

Technische Daten

Material

Körper (2), Mutter (1), Gewinde (5): Messing

Seeger Ring (4): Bronze

O-Ring (3): NBR 70 (andere auf Anfrage)

Gewinde:

- zylindrisches Gewinde mit gekammertem O-Ring UNI-ISO 228/1
- metrisches Gewinde mit gekammertem O-Ring UNI 5542-65
- konisches Gewinde UNI-ISO7/1
- konisches Gewinde NPT ANSI/ASME B1.20.1
- zylindrisches Innengewinde UNI-ISO 228/1
- andere Spezialgewinde auf Anfrage

Betriebsdruck: -0,99 bis 15 bar (abhängig vom Material des Schlauches)

Betriebstemperatur: -20°C bis +80°C, 273°K bis 353°K (abhängig vom Material des Schlauches und O-Ring)

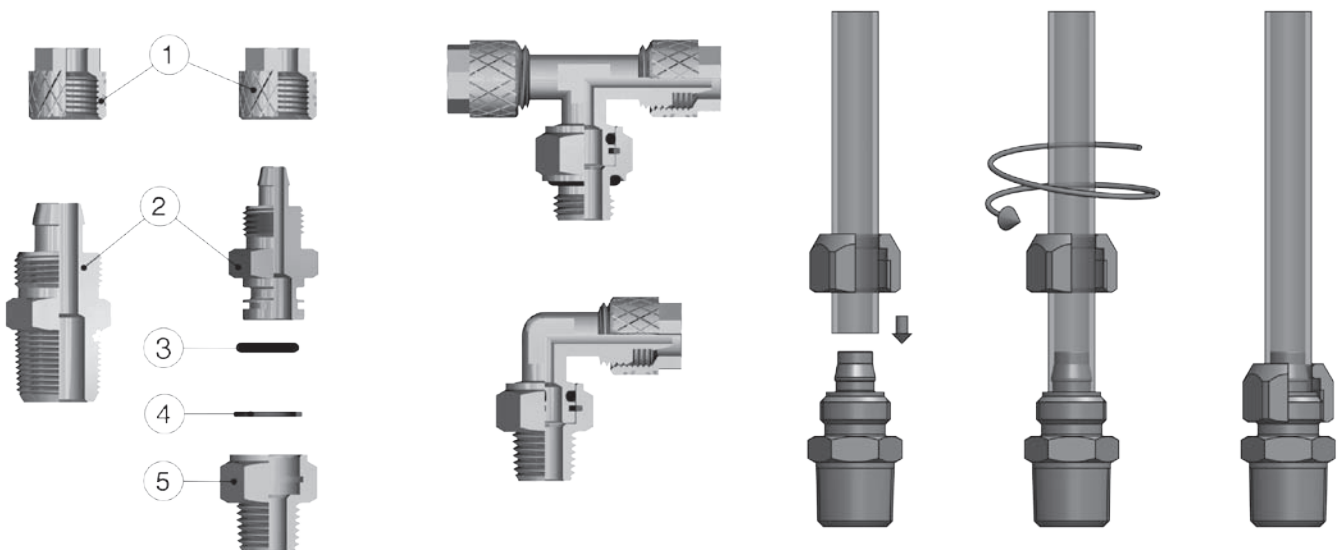

Schnellverschraubung, Messing vernickelt

Serie

151.01.

Gerader Einschraubanschluss
zylindrisches Gewinde UNI-ISO 228/1



Artikel-Nr.	A	Schlauch	L	B	E	F	G	CH	CH1
151.01.04.10	1/8	4/2,7	23,0	6				13	7
151.01.05.10	1/8	5/3	25,1	6				14	8
151.01.06.10	1/8	6/4	25,1	6				14	10
151.01.06.13	1/4	6/4	28,0	8				17	10
151.01.06.17	3/8	6/4	29,0	9				19	10
151.01.06.21	1/2	6/4	32,0	10				24	10
151.01.08.10	1/8	8/6	26,4	6				14	12
151.01.08.13	1/4	8/6	29,4	8				17	12
151.01.08.17	3/8	8/6	30,5	9				19	12
151.01.08.21	1/2	8/6	32,0	10				24	12
151.01.10.10	1/8	10/8	28,5	6				14	14
151.01.10.13	1/4	10/8	31,5	8				17	14
151.01.10.17	3/8	10/8	32,5	9				19	14
151.01.10.21	1/2	10/8	34,5	10				24	14
151.01.12.17	3/8	12/10	34,0	9				19	15
151.01.12.21	1/2	12/10	36,0	10				24	15
151.01.15.21	1/2	15/12,5	38,0	10				24	19

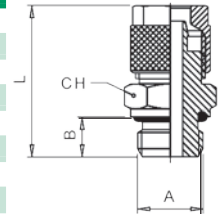

Serie

151.01.

Gerader Einschraubanschluss
metrisches Gewinde UNI-5542-65



Artikel-Nr.	A	Schlauch	L	B	E	F	G	CH	CH1
151.01.04.08	M5	4/2,7	20,5	4				8	7
151.01.04.32	M6	4/2,7	20,5	5				8	7
151.01.05.08	M5	5/3	20,5	4				8	8
151.01.05.32	M6	5/3	21,0	5				8	8
151.01.06.08	M5	6/4	21,5	4				8	10
151.01.06.32	M6	6/4	22,5	5				8	10
151.01.06.51	M12x1	6/4	28,1	8				15	10
151.01.06.52	M12x1,25	6/4	28,0	8				15	10
151.01.06.53	M12x1,5	6/4	28,0	8				15	10

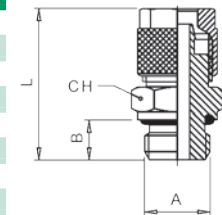

Serie

151.05.

Gerader Einschraubanschluss
konisches Gewinde UNI-ISO 7/1



Artikel-Nr.	A	B	C	B	E	F	G	CH	CH1
151.05.04.10	1/8	4/2,7	23,5	7,5				12	7
151.05.05.10	1/8	5/3	23,0	8				12	8
151.05.06.10	1/8	6/4	25,6	8				12	10
151.05.06.13	1/4	6/4	29,6	11				14	10
151.05.06.17	3/8	6/4	30,0	11				17	10
151.05.08.10	1/8	8/6	26,9	8				13	12
151.05.08.13	1/4	8/6	30,9	11				14	12
151.05.08.17	3/8	8/6	31,4	11				14	12
151.05.08.21	1/2	8/6	34,0	14				22	12
151.05.10.10	1/8	10/8	29,0	8				14	14
151.05.10.13	1/4	10/8	33,0	8				17	14
151.05.10.17	3/8	10/8	33,5	11				17	14
151.05.10.21	1/2	10/8	36,5	14				22	14
151.05.12.13	1/4	12/10	34,0	11				17	19
151.05.12.17	3/8	12/10	35,0	11				17	15
151.05.12.21	1/2	12/10	38,0	14				22	15
151.05.15.21	1/2	15/12,5	40,0	14				22	19

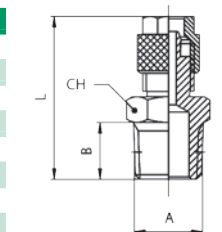

Schnellverschraubung, Messing vernickelt

Serie

151.51.



Gerader Einschraubanschluss, drehbar
zylindrisches Gewinde UNI-ISO 228/1

Artikel-Nr.	A	Schlauch	L	B	E	F	CH	CH1	CH2
151.51.06.10	1/8	6/4	34,0	6				12	13
151.51.06.13	1/4	6/4	38,0	8				14	16
151.51.08.10	1/8	8/6	34,0	8				12	13
151.51.08.13	1/4	8/6	38,0	8				14	16
151.51.10.13	1/4	10/8	39,0	8				14	16
151.51.12.17	3/8	12/10	42,5	9				17	18

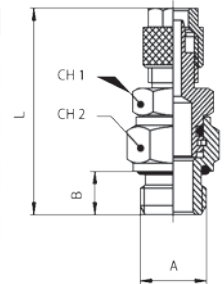

Serie

151.55.



Gerader Einschraubanschluss, drehbar
konisches Gewinde UNI-ISO 7/1

Artikel-Nr.	A	B	L	B	E	F	CH	CH1	CH2
151.55.06.10	1/8	6/4	33,5	7,5				12	13
151.55.06.13	1/4	6/4	40,0	11				14	16
151.55.08.10	1/8	8/6	33,5	7,5				12	13
151.55.08.13	1/4	8/6	40,0	11				14	16
151.55.10.13	1/4	10/8	41,0	11				14	16
151.55.12.17	3/8	12/10	43,5	11,5				17	18

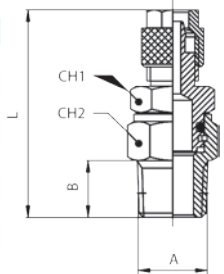

Serie

151.09.



Winkel-Einschraubanschluss, fest
konisches Gewinde UNI-ISO 7/1

Artikel-Nr.	A	Schlauch	L2	B	L1	F	G	CH	CH1
151.09.04.10	1/8	4/2,7	15,0	7,5	19,5			8	7
151.09.05.10	1/8	5/3	15,0	7,5	19,5			8	8
151.09.06.10	1/8	6/4	15,0	7,5	19,5			8	8
151.09.06.13	1/4	6/4	19,0	11,0	20,6			8	8
151.09.06.17	3/8	6/4	21,0	11,5	21,0			9	8
151.09.08.10	1/8	8/6	16,5	7,5	19,9			9	12
151.09.08.13	1/4	8/6	19,0	11,0	21,9			9	12
151.09.08.17	3/8	8/6	21,0	11,5	23,4			9	12
151.09.08.21	1/2	8/6	28,0	14,0	26,0			16	12
151.09.10.10	1/8	10/8	18,0	7,5	25,0			11	14
151.09.10.13	1/4	10/8	22,0	11,0	24,0			11	14
151.09.10.17	3/8	10/8	22,5	12,5	25,5			11	14
151.09.10.21	1/2	10/8	28,0	14,0	28,0			16	14
151.09.12.13	1/4	12/10	24,0	11,0	28,5			13	19
151.09.12.17	3/8	12/10	22,5	11,5	27,0			13	15
151.09.12.21	1/2	12/10	28,0	14,0	30,0			16	15
151.09.15.21	1/2	15/12,5	28,0	14,0	31,5			16	19

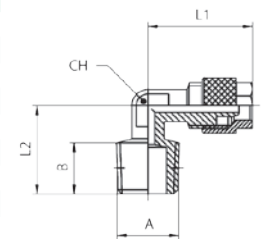

Serie

151.09.



Winkel-Einschraubanschluss
metrisches Gewinde UNI-5542-65

Artikel-Nr.	A	B	L2	B	L1	F	G	CH	CH1
151.09.05.08	M5	5/3	13	4	21,5			9	9
151.09.06.08	M5	6/4	13	4	20,0			9	9
151.09.06.32	M6	6/4	13	5	20,0			9	9
151.09.06.51	M12x1	6/4	21	9	22,5			10	12
151.09.06.52	M12x1,25	6/4	21	9	22,5			10	12
151.09.06.53	M12x1,5	6/4	21	9	22,5			10	12
151.09.08.52	M12x1,25	8/6	21	9	22,5			10	14
151.09.08.53	M12x1,5	8/6	21	9	22,5			10	14

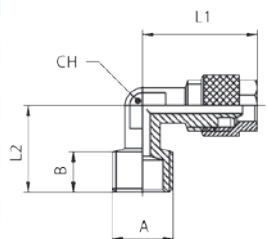

Schnellverschraubung, Messing vernickelt

Serie

151.91.

Winkel-Einschraubanschluss, drehbar
zylindrisches Gewinde UNI-ISO 228/1



Artikel-Nr.	A	Schlauch	L2	B	L1	F	G	CH1	CH2
151.91.04.10	1/8	4/2,7	22,0	6	18,5			8	13
151.91.06.10	1/8	6/4	22,0	6	20,6			8	13
151.91.06.13	1/4	6/4	26,0	8	20,6			8	16
151.91.08.10	1/8	8/6	22,0	6	21,6			9	13
151.91.08.13	1/4	8/6	26,5	8	23,1			9	16
151.91.10.13	1/4	10/8	27,5	8	24,0			11	16

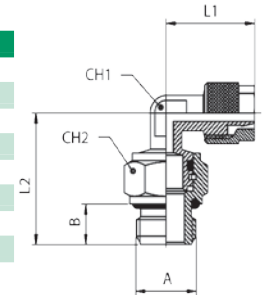

Serie

151.79.

Winkel-Einschraubanschluss, drehbar
konisches Gewinde UNI-ISO 7/1



Artikel-Nr.	A	Schlauch	L2	D	L1	F	G	CH1	CH2
151.79.04.10	1/8	4/2,7	22,5	7,5	20,0			8	13
151.79.06.10	1/8	6/4	22,5	7,5	20,6			8	13
151.79.06.13	1/4	6/4	28,0	11,0	20,6			8	15
151.79.08.10	1/8	8/6	22,5	7,5	21,6			9	13
151.79.08.13	1/4	8/6	28,5	11,0	23,1			9	15
151.79.10.13	1/4	10/8	30,5	11,0	24,0			11	15
151.79.10.17	3/8	10/8	29,0	11,0	26,0			11	16

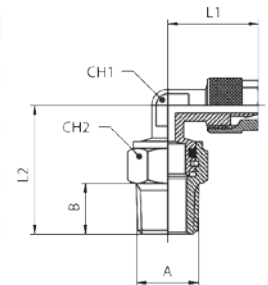

Serie

151.98.

T-Einschraubanschluss, drehbar
zylindrisches Gewinde UNI-ISO 228/1



Artikel-Nr.	A	Schlauch	L1	B	L2	F	G	CH1	CH2
151.98.06.10	1/8	6/4	41,2	6	22,0			8	13
151.98.06.13	1/4	6/4	41,2	8	26,0			8	16
151.98.08.10	1/8	8/6	43,2	6	24,0			9	13
151.98.08.13	1/4	8/6	43,2	8	27,5			9	16
151.98.10.10	1/8	10/8	48,0	6	22,5			11	13
151.98.10.13	1/4	10/8	48,0	8	27,5			9	16

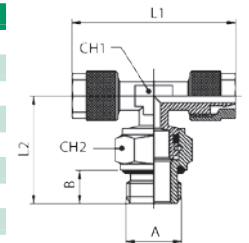

Serie

151.08.

T-Einschraubanschluss, fest
konisches Gewinde UNI-ISO 7/1



Artikel-Nr.	A	Schlauch	L2	B	L1	F	G	CH	CH1
151.08.04.10	1/8	4/2,7	15,5	7,5	37,0			8	7
151.08.05.08*	M5	5/3	14,5	4	43,0			8	8
151.08.05.10	1/8	5/3	17,0	8	39,0			8	8
151.08.06.10	1/8	6/4	17,0	8	39,0			8	8
151.08.06.13	1/4	6/4	21,0	11	41,2			9	8
151.08.06.17	3/8	6/4	22,5	11	47,0			11	12
151.08.08.10	1/8	8/6	20,0	8	39,8			11	12
151.08.08.13	1/4	8/6	21,0	11	43,8			11	12
151.08.08.17	3/8	8/6	24,0	11	47,0			11	14
151.08.10.10	1/8	10/8	18,5	8	48,0			11	14
151.08.10.13	1/4	10/8	23,0	11	48,0			11	14
151.08.10.17	3/8	10/8	23,0	11	51,0			11	14
151.08.10.21	1/2	10/8	29,0	14	60,0			17	16
151.08.12.17	3/8	12/10	25,0	11	54,0			14	15
151.08.12.21	1/2	12/10	28,0	14	60,0			17	18
151.08.15.21	1/2	15/12,5	28,0	14	63,0			16	22

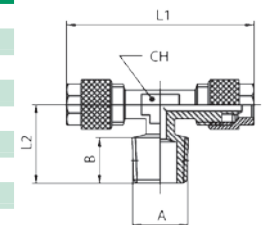

* metrisches Gewinde

Schnellverschraubung, Messing vernickelt

**Serie
151.03.**

L-Einschraubanschluss, fest
konisches Gewinde UNI-ISO 7/1



Artikel-Nr.	A	Schlauch	L1	B	L2	F	G	CH	CH1
151.03.05.08	M5	5/3	29,0	4,0	21,5			8	8
151.03.05.10	1/8	5/3	36,7	7,5	20,6			8	8
151.03.06.10	1/8	6/4	36,7	7,5	20,6			8	10
151.03.06.13	1/4	6/4	40,2	11,0	20,6			8	10
151.03.06.17	3/8	6/4	44,0	11,0	23,5			11	12
151.03.08.10	1/8	8/6	38,0	7,5	21,9			9	12
151.03.08.13	1/4	8/6	41,5	11,0	21,9			9	12
151.03.08.17	3/8	8/6	46,0	11,5	25,0			11	14
151.03.10.10	1/8	10/8	40,0	7,5	25,5			11	14
151.03.10.13	1/4	10/8	43,0	11,0	25,5			11	14
151.03.10.17	3/8	10/8	44,0	11,5	25,5			11	14
151.03.10.21	1/2	10/8	58,0	14,0	28,0			17	16
151.03.12.17	3/8	12/10	48,0	11,5	28,0			13	15
151.03.12.21	1/2	12/10	47,5	14,0	30,0			17	18
151.03.15.21	1/2	15/12,5	47,5	14,0	32,5			16	19

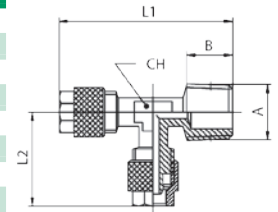

**Serie
151.14.**

Gerader Aufsraubanschluss
zylindrisches Gewinde UNI-ISO 228/1



Artikel-Nr.	A	Schlauch	L	B	E	F	G	CH	CH1
151.14.05.10	1/8	5/3	22,5	8,0				14	8
151.14.06.10	1/8	6/4	23,3	8,5				17	10
151.14.06.13	1/4	6/4	27,0	11,0				17	10
151.14.06.17	3/8	6/4	28,0	11,5				22	10
151.14.08.10	1/8	8/6	24,7	8,0				14	12
151.14.08.13	1/4	8/6	28,7	11,0				17	12
151.14.08.17	3/8	8/6	29,2	11,5				22	12
151.14.08.21	1/2	8/6	33,0	15,5				24	12
151.14.10.10	1/8	10/8	26,5	8,0				14	16
151.14.10.13	1/4	10/8	30,5	11,0				17	14
151.14.10.17	3/8	10/8	31,0	11,5				22	14
151.14.10.21	1/2	10/8	34,5	15,5				24	14
151.14.12.17	3/8	12/10	32,5	11,5				22	15

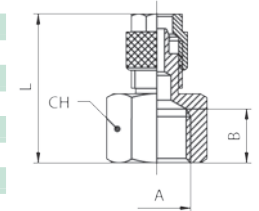

**Serie
151.69.**

Winkel-Aufsraubanschluss
zylindrisches Gewinde UNI-ISO 228/1



Artikel-Nr.	A	Schlauch	L1	B	L2	F	G	CH	CH1
151.69.05.10	1/8	5/3	20,6	8,5	18,0			8	7
151.69.06.10	1/8	6/4	20,6	8,5	18,0			8	8
151.69.06.13	1/4	6/4	21,0	10,5	21,0			9	8
151.69.08.10	1/8	8/6	21,9	8,5	19,0			9	12
151.69.08.13	1/4	8/6	23,4	10,5	21,0			9	12
151.69.10.13	1/4	10/8	25,5	10,5	22,5			11	14
151.69.10.17	3/8	10/8	28,0	11,5	27,0			16	14

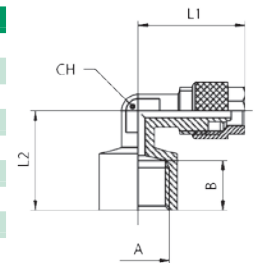

**Serie
151.02.**

Winkel-Verbinder



Artikel-Nr.	Schlauch	L	D	E	F	CH	CH1	CH2
151.02.04.00	4/2,7	4/2,7	20,0			8	7	
151.02.05.00	5/3	5/3	20,6			8	8	
151.02.06.00	6/4	6/4	20,6			8	8	
151.02.08.00	8/6	8/6	21,9			9	10	
151.02.10.00	10/8	10/8	25,5			11	14	
151.02.12.00	12/10	12/10	27,0			13	15	
151.02.15.00	15/12,5	15/12,5	33,5			16	19	
151.02.08.06	8/6	6/4	21,9			9	8	10

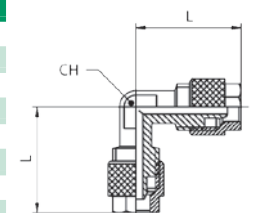

Schnellverschraubung, Messing vernickelt

Serie

151.04.



T-Verbinder

Artikel-Nr.	Schlauch	L1	L2	E	F	CH	CH1	CH2
151.04.04.00	4/2,7	4/2,7	40,0	20,5		8	7	7
151.04.05.00	5/3	5/3	41,2	20,6		8	8	8
151.04.06.00	6/4	6/4	41,2	20,6		8	10	10
151.04.08.00	8/6	8/6	43,8	21,9		9	12	12
151.04.10.00	10/8	10/8	51,0	25,5		11	14	14
151.04.12.00	12/10	12/10	54,0	28,0		13	15	15
151.04.15.00	15/12,5	15/12,5	63,0	32,5		16	19	19
151.04.08.06	8/6	6/4	43,8	20,6		9	12	10
151.04.10.06	10/8	6/4	51,0	20,6		11	14	10
151.04.10.08	10/8	8/6	51,0	21,9		11	14	12

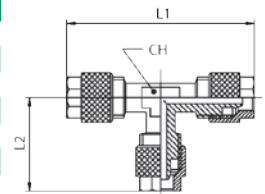

Serie

151.06.



Gerader Verbinder

Artikel-Nr.	Schlauch	L	E	F	CH	CH1	CH2
151.06.04.00	4/2,7	4/2,7	27,5		8	7	7
151.06.05.00	5/3	5/3	31,7		8	8	8
151.06.06.00	6/4	6/4	32,2		12	10	10
151.06.08.00	8/6	8/6	34,8		12	12	12
151.06.10.00	10/8	10/8	39,0		14	14	14
151.06.12.00	12/10	12/10	43,0		17	15	15
151.06.15.00	15/12,5	15/12,5	47,0		22	19	19
151.06.06.05	6/4	5/3	32,2		12	10	8
151.06.08.06	8/6	6/4	35,0		12	12	10
151.06.10.06	10/8	6/4	35,6		14	14	10
151.06.10.08	10/8	8/6	36,9		14	14	12

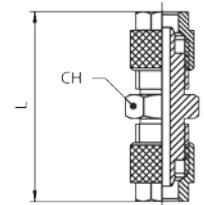

Serie

151.07.



Kreuz-Verbinder

Artikel-Nr.	Schlauch	L	C	D	E	F	CH	CH1	CH2
151.07.05.00	5/3	41,6					8	8	
151.07.06.00	6/4	41,6					8	10	
151.07.08.00	8/6	44,4					9	12	
151.07.10.00	10/8	49,0					11	14	
151.07.12.00	12/10	58,0					13	15	
151.07.15.00	15/12,5	64,0					17	19	

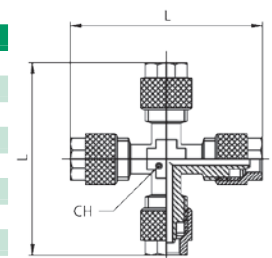

Serie

151.16.



Gerader-Schott-Verbinder

Artikel-Nr.	Schlauch	B _{max}	L	A	E	F	CH	CH1	CH2
151.16.04.00	4/2,7		35,0	M6x0,5			10	7	
151.16.05.00	5/3	8,5	35,0	M7x0,75			10	8	
151.16.06.00	6/4	10,5	45,5	M10x1			14	10	
151.16.08.00	8/6	12,0	48,4	M12x1			17	12	
151.16.10.00	10/8	10,0	52,0	M14x1			17	14	
151.16.12.00	12/10	10,0	57,0	M16x1			19	15	
151.16.15.00	15/12,5	8,5	59,0	M20x1			24	19	
151.16.06.05	6/4-5/3		45,5	M10x1			14	10	8
151.16.08.06	8/6-6/4		47,3	M12x1			17	12	10
151.16.10.06	10/8-6/4		49,8	M14x1			17	14	10
151.16.10.08	10/8-8/6		51,2	M14x1			17	14	12

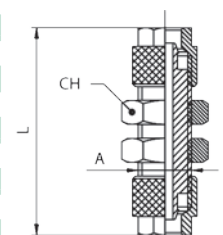

Schnellverschraubung, Messing vernickelt

**Serie
151.11.**



Winkel-Ringanschluss

Artikel-Nr.	A	Schlauch	S	L	D	F	G	CH	CH1
151.11.04.08	M5	4/2,7	12,5	21,5	9			7	
151.11.04.10	1/8	4/2,7	15,0	23,3	14			7	
151.11.04.32	M6	4/2,7	12,5	21,5	9			7	
151.11.05.08	M5	5/3	12,5	21,5	9			8	
151.11.05.10	1/8	5/3	15,0	23,3	14			8	
151.11.06.08	M5	6/4	12,5	21,5	9			10	
151.11.06.10	1/8	6/4	15,0	23,3	14			10	
151.11.06.13	1/4	6/4	17,0	25,3	18			10	
151.11.06.17	3/8	6/4	20,0	26,8	21			10	
151.11.06.32	M6	6/4	12,5	21,5	9			10	
151.11.08.10	1/8	8/6	15,0	24,7	14			12	
151.11.08.13	1/4	8/6	17,0	27,6	18			12	
151.11.08.17	3/8	8/6	20,0	27,7	21			12	
151.11.08.21	1/2	8/6	24,0	31,2	26			12	
151.11.10.10	1/8	10/8	15,0	27,5	14			14	
151.11.10.13	1/4	10/8	17,0	29,5	18			14	
151.11.10.17	3/8	10/8	20,0	30,5	21			14	
151.11.10.21	1/2	10/8	24,0	34,0	26			14	
151.11.12.17	3/8	12/10	20,0	31,5	21			15	
151.11.12.21	1/2	12/10	24,0	35,0	26			15	
151.11.15.21	1/2	15/12,5	24,0	36,5	26			19	

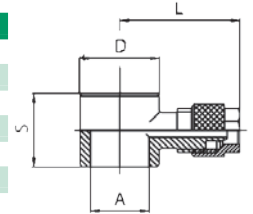

Hohlschrauben siehe 101.10, Seite 13

**Serie
151.12.**



T-Ringanschluss

Artikel-Nr.	A	Schlauch	S	L	D	F	G	CH	CH1
151.12.04.08	M5	4/2,7	12,5	43,0				7	
151.12.04.10	1/8	4/2,7	15,0	46,6				7	
151.12.05.08	M5	5/3	12,5	43,0				8	
151.12.05.10	1/8	5/3	15,0	46,6				8	
151.12.06.08	M5	6/4	12,5	43,0				10	
151.12.06.10	1/8	6/4	15,0	46,6				10	
151.12.06.13	1/4	6/4	17,0	50,6				10	
151.12.06.17	3/8	6/4	20,0	53,6				10	
151.12.08.10	1/8	8/6	15,0	49,4				12	
151.12.08.13	1/4	8/6	17,0	55,2				12	
151.12.08.17	3/8	8/6	20,0	55,0				12	
151.12.08.21	1/2	8/6	24,0	61,0				12	
151.12.10.10	1/8	10/8	15,0	53,0				14	
151.12.10.13	1/4	10/8	17,0	59,0				14	
151.12.10.17	3/8	10/8	20,0	61,0				14	
151.12.10.21	1/2	10/8	24,0	64,0				14	
151.12.12.17	3/8	12/10	20,0	63,0				15	
151.12.12.21	1/2	12/10	24,0	70,0				15	
151.12.15.21	1/2	15/12,5	24,0	73,0				19	

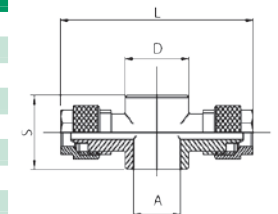

Hohlschrauben siehe 101.10, Seite 10

**Serie
151.88.**



T-Einschraubanschluss, drehbar
konisches Gewinde UNI-ISO 7/1

Artikel-Nr.	A	Schlauch	B	L1	L2	CH	CH1	CH2
151.88.06.10	1/8	6/4	7,5	41,2	22,5		8	13
151.88.06.13	1/4	6/4	11,0	41,2	28,0		8	15
151.88.08.10	1/8	8/6	7,5	43,2	24,5		9	13
151.88.08.13	1/4	8/6	11,0	43,2	29,5		9	15
151.88.10.13	1/4	10/8	11,5	48,0	29,5		11	15

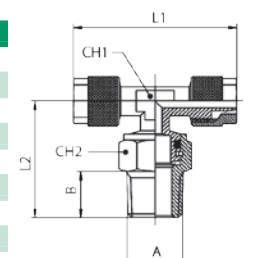

Schnellverschraubung, Messing vernickelt

Serie 151.90.



Winkel-Verbinder mit Innensechskant und O-Ring

Artikel-Nr.	A	B	C	D	E	F	CH	CH1	CH2
151.90.05.10	1/8	5/3	13,5	5	22,5	14,0	4		8
151.90.05.13	1/4	5/3	15,0	6	24,0	14,3	4		8
151.90.06.10	1/8	6/4	13,5	5	26,0	14,0	4		12
151.90.06.13	1/4	6/4	15,0	6	24,0	14,3	4		12
151.90.08.10	1/8	8/6	13,5	5	26,0	14,0	4		14
151.90.08.13	1/4	8/6	15,0	6	28,0	14,3	4		14

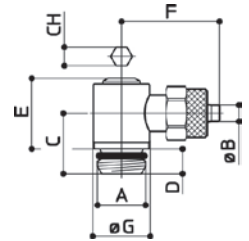

Serie 151.29.



Winkel-Verbinder mit Innen- und Außensechskant und O-Ring, lang

Artikel-Nr.	A	B	C	D	E	F	CH	CH1	CH2
151.29.05.10	1/8	5/3	30,5	5	22,5	14,0	4	10	8
151.29.05.13	1/4	5/3	32,0	6	24,0	14,3	4	10	8
151.29.06.10	1/8	6/4	30,5	5	26,0	14,0	4	10	12
151.29.06.13	1/4	6/4	32,0	6	24,0	14,3	4	10	12
151.29.08.10	1/8	8/6	30,5	5	26,0	14,0	4	10	14
151.29.08.13	1/4	8/6	32,0	6	28,0	14,3	4	10	14

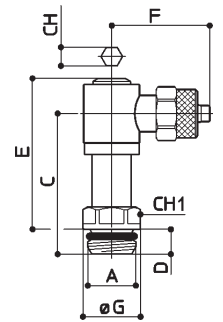

Serie 151.97.



T-Verbinder mit Innensechskant und O-Ring

Artikel-Nr.	A	B	C	D	E	F	CH	CH1	CH2
151.97.05.10	1/8	5/3	13,5	5	22,5	14,0	4		8
151.97.05.13	1/4	5/3	15,0	6	24,0	14,3	4		8
151.97.06.10	1/8	6/4	13,5	5	26,0	14,0	4		12
151.97.06.13	1/4	6/4	15,0	6	24,0	14,3	4		12
151.97.08.10	1/8	8/6	13,5	5	26,0	14,0	4		14
151.97.08.13	1/4	8/6	15,0	6	28,0	14,3	4		14

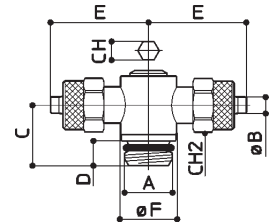

Serie 151.96.



T-Verbinder mit Innen- und Außensechskant und O-Ring, lang

Artikel-Nr.	A	B	C	D	E	F	CH	CH1	CH2
151.96.05.10	1/8	5/3	30,5	5	22,5	14,0	4	10	8
151.96.05.13	1/4	5/3	32,0	6	24,0	14,3	4	10	8
151.96.06.10	1/8	6/4	30,5	5	26,0	14,0	4	10	12
151.96.06.13	1/4	6/4	32,0	6	24,0	14,3	4	10	12
151.96.08.10	1/8	8/6	30,5	5	26,0	14,0	4	10	14
151.96.08.13	1/4	8/6	32,0	6	28,0	14,3	4	10	14

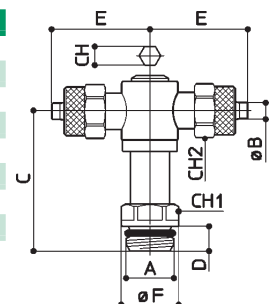

Schnellverschraubung, Messing vernickelt

Serie
151.36.

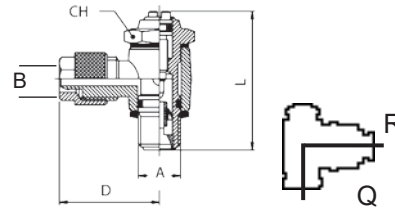

Drossel-Verschraubung

positionierbar, zylindrisches Gewinde: UNI-ISO 228/1- metrisches Gewinde: UNI 5542-65

Artikel-Nr.	A	B	C	D	L	F	CH	CH1	NW	Q-R
151.X.04.08	M5	4/2,7		21,5	24,0		8		1,5	0-43l/min
151.X.04.10	1/8	4/2,7		23,3	30,5		14		2,0	0-160l/min
151.X.06.08	M5	6/4		21,5	24,0		8		1,5	0-43l/min
151.X.06.10	1/8	6/4		23,3	30,5		14		2,0	0-160l/min
151.X.06.13	1/4	6/4		25,3	35,5		17		3,5	0-410l/min
151.X.08.10	1/8	8/6		24,7	30,5		14		2,0	0-160l/min
151.X.08.13	1/4	8/6		27,6	35,5		17		3,5	0-410l/min
151.X.08.17	3/8	8/6		27,7	41,0		20		6,0	0-1050l/min
151.X.10.13	1/4	10/8		29,5	35,5		17		3,5	0-410l/min
151.X.10.17	3/8	10/8		30,5	41,0		20		6,0	0-1050l/min
151.X.12.17	3/8	12/10		31,5	41,0		20		6,0	0-1050l/min
151.X.12.21	1/2	12/10		35,0	47,0		24		6,0	0-1300l/min
161.X.15.21	1/2	15/12,5		36,5	47,0		24		6,0	0-1300l/min

Für Handrad bitte ein "V" anfügen

X=36=Abluft, X=37=Zuluft X=43=beidseitige Drossel

Serie
151.36.

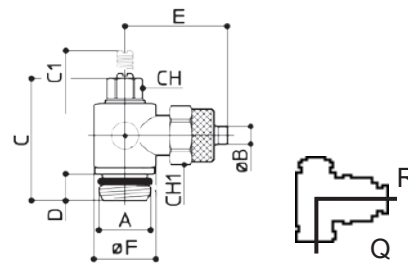

Drossel-Verschraubung

Schwenkbar, zylindrisches Gewinde: UNI-ISO 228/1

Artikel-Nr.	A	B	C	D	E	F	CH	CH1	NW	Q-R	R-Q
151.X.05.10.Y	1/8	5/3	29,5	6	22,5	14	8	8	2,8	0-310l/min	320l/min
151.X.06.10.Y	1/8	6/4	29,5	6	24,0	14	8	12	2,8	0-500l/min	550l/min
151.X.06.13.Y	1/4	6/4	34,0	7	26,0	18	10	12	4,5	0-550l/min	670l/min
151.X.08.10.Y	1/8	8/6	29,5	6	24,0	14	8	14	2,8	0-480l/min	600l/min
151.X.08.13.Y	1/4	8/6	34,0	7	26,0	18	10	14	4,5	0-950l/min	970l/min
151.X.10.13.Y	1/4	10/8	34,0	7	28,0	18	10	16	4,5	0-950l/min	970l/min

Für Handrad bitte ein "V" anfügen

X=36=Abluft X=37=Zuluft X=43=beidseitige Drossel
Y=CD=Abluft Y=CR=Zuluft Y=CN=beidseitige Drossel

siehe auch Seite 112/113

Schnellverschraubung, Messing vernickelt

Serie

101.24.



Einfache Aufschraubhohlschraube
zylindrisches Gewinde UNI-ISO 228/1

Artikel-Nr.	A	B	C	D	E	F	G	CH	CH1
101.24.01.10	1/8	14	35	6,0			23,0	14	
101.24.01.13	1/4	16	40	6,5			25,5	17	

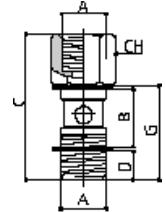

Serie

101.10.01



Einfache Hohlschraube
zylindrisches Gewinde UNI-ISO 228/1

Artikel-Nr.	A	B	C	D	E	F	G	CH	CH1
101.10.01.08	M5	9	19,5	5,0			16,0	8	
101.10.01.10	1/8	14	27,0	6,0			23,0	14	
101.10.01.13	1/4	16	29,5	6,5			25,5	17	

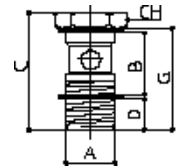

Serie

101.10...D



Einfache Hohlschraube mit Druckanzeige
zylindrisches Gewinde UNI-ISO 228/1

Artikel-Nr.	A	B	C	D	E	F	G	CH	CH1
101.10.01.10.D	1/8	14	32	6,0			23,0	14	
101.10.01.13.D	1/4	16	34	6,5			25,5	17	

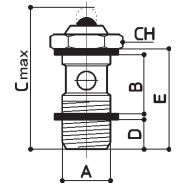

Serie

101.10.02



Zweifache Hohlschraube
zylindrisches Gewinde UNI-ISO 228/1

Artikel-Nr.	A	B	C	D	E	F	G	CH	CH1
101.10.02.08	M5	9	28,5	4,0			25	8	
101.10.02.10	1/8	14	43,0	6,5			39	14	
101.10.02.13	1/4	16	46,0	5,5			42	17	

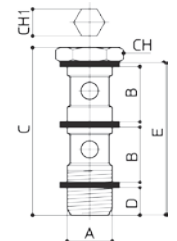

Serie

101.10.03



Dreifache Hohlschraube
zylindrisches Gewinde UNI-ISO 228/1

Artikel-Nr.	A	B	C	D	E	F	G	CH	CH1
101.10.03.10	1/8	14	58,5	6,5			54,5	14	
101.10.03.13	1/4	16	64,0	6,0			60,0	17	

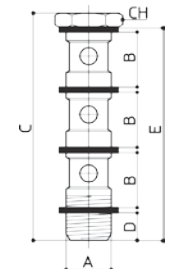

Serie

151.10.

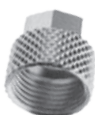

Überwurmmutter

Artikel-Nr.	A	Schlauch	C	L	CH
151.10.04.00	M6x0.5	4/2.7		9,0	7
151.10.05.00	M7x0.75	5/3		11,0	8
151.10.06.00	M10x1	6/4		11,0	10
151.10.08.00	M12x1	8/6		11,5	12
151.10.10.00	M14x1	10/8		13,5	14
151.10.12.00	M16x1	12/10		15,0	15
151.10.15.00	M20x1	15/12.5		16,0	19

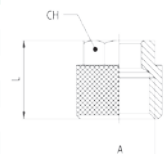

Schnellverschraubung, Messing vernickelt

Serie

151.1025.

Schnellverschraubung mit Knickschutzfeder,
Gewinde konisch, fest



Artikel-Nr.	A	Schlauch	B	L	CH
151.1025.06.10	1/8	6/4	7,5	109,5	12
151.1025.06.13	1/4	6/4	11,0	113,5	14
151.1025.08.10	1/8	8/6	7,51	116,0	14
151.1025.08.13	1/4	8/6	11,0	120,0	14
151.1025.08.17	3/8	8/6	11,5	120,5	17
151.1025.08.21	1/2	8/6	14,0	123,0	22
151.1025.10.10	1/8	10/8	7,5	124,0	14
151.1025.10.13	1/4	10/8	11,0	128,0	14
151.1025.10.17	3/8	10/8	11,5	128,5	17
151.1025.10.21	1/2	10/8	14,0	131,5	22
151.1025.12.17	3/8	12/10	11,5	136,5	17
151.1025.12.21	1/2	12/10	14,0	139,5	22

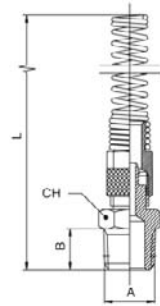

Serie

151.1026.

Schnellverschraubung mit Knickschutzfeder,
Gewinde konisch, drehbar



Artikel-Nr.	A	Schlauch	B	L	CH1	CH2
151.1026.06.10	1/8	6/4	7,5	117,5	12	13
151.1026.06.13	1/4	6/4	11,0	124,5	14	15
151.1026.08.10	1/8	8/6	7,5	123,0	12	13
151.1026.08.13	1/4	8/6	11,0	129,0	14	15
151.1026.10.13.01	1/4	10/6.5	11,0	136,0	14	15
151.1026.10.13	1/4	10/8	11,0	136,0	14	15
151.1026.12.17.01	3/8	12/8	11,5	145,0	17	17
151.1026.12.17	3/8	12/10	11,5	145,0	17	17

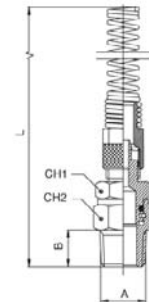

Serie

151.1027.

Schnellverschraubung mit Knickschutzfeder,
Gewinde zylindrisch mit O-Ring, drehbar



Artikel-Nr.	A	Schlauch	B	L	CH1	CH2
151.1027.06.10	1/8	6/4	6	118	12	13
151.1027.06.13	1/4	6/4	8	122	14	16
151.1027.08.10	1/8	8/6	6	123	12	13
151.1027.08.13	1/4	8/6	8	127	14	16
151.1027.10.13.01	1/4	10/6.5	8	134	14	16
151.1027.10.13	1/4	10/8	8	134	14	16
151.1027.12.17.01	3/8	12/8	9	142	17	18
151.1027.12.17	3/8	12/10	9	142	17	18

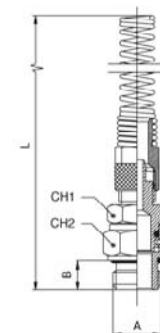

Schnellverschraubung, Messing vernickelt

Serie

151.1028.

Schnellverschraubung mit Knickschutzfeder,
Gewinde zylindrisch mit O-Ring, fest



Artikel-Nr.	A	Schlauch	B	L	CH
151.1028.06.10	1/8	6/4	6	109,0	13
151.1028.06.13	1/4	6/4	8	112,0	16
151.1028.06.17	3/8	6/4	9	113,0	19
151.1028.06.21	1/2	6/4	10	116,0	24
151.1028.08.10	1/8	8/6	6	115,5	14
151.1028.08.13	1/4	8/6	8	118,5	16
151.1028.08.17	3/8	8/6	9	119,5	19
151.1028.08.21	1/2	8/6	10	121,0	24
151.1028.10.10	1/8	10/8	6	123,5	14
151.1028.10.13	1/4	10/8	8	126,0	16
151.1028.10.17	3/8	10/8	9	127,5	19
151.1028.10.21	1/2	10/8	10	129,5	24
151.1028.12.17	3/8	12/10	9	135,5	19
151.1028.12.21	1/2	12/10	10	137,5	24

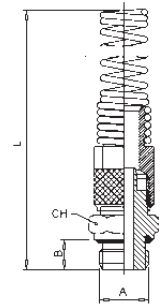

Serie

151.1029.

Schnellverschraubung mit Knickschutzfeder,
Gewinde metrisch mit O-Ring, fest



Artikel-Nr.	A	Schlauch	B	L	CH
151.1029.06.10	M12x1	6/4	8	112	15
151.1029.06.13	M12x1.25	6/4	8	112	15
151.1029.06.17	M12x1.5	6/4	8	112	15

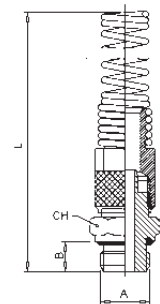

Serie

151.1035.

Schnellverschraubung mit Knickschutzfeder,
Innengewinde zylindrisch, fest



Artikel-Nr.	A	Schlauch	B	L	CH
151.1035.06.10	1/8	6/4	8,5	107,5	14
151.1035.06.13	1/4	6/4	11,0	111,0	17
151.1035.06.17	3/8	6/4	11,5	112,0	22
151.1035.08.10	1/8	8/6	8,0	114,0	14
151.1035.08.13	1/4	8/6	11,0	117,5	17
151.1035.08.17	3/8	8/6	11,5	118,5	22
151.1035.08.21	1/2	8/6	15,5	121,5	24
151.1035.10.13	1/4	10/8	11,0	125,5	17
151.1035.10.17	3/8	10/8	11,5	128,0	22
151.1035.10.21	1/2	10/8	15,5	129,5	24
151.1035.12.17	3/8	12/10	11,5	136,0	22

